

July 1994

## 850MHz Current Feedback Amplifier

### Features

- This Circuit is Processed in Accordance to MIL-STD-883 and is Fully Conformant Under the Provisions of Paragraph 1.2.1.
- Low Distortion (HD3, 30MHz) . . . . . -84dBc (Typ)
- Wide -3dB Bandwidth . . . . . 850MHz (Typ)
- Very High Slew Rate . . . . . 2300V/μs (Typ)
- Fast Settling (0.1%) . . . . . 11ns (Typ)
- Excellent Gain Flatness (to 50MHz) . . . . . 0.05dB (Typ)
- High Output Current . . . . . 65mA (Typ)
- Fast Overdrive Recovery . . . . . <10ns (Typ)

### Applications

- Video Switching and Routing
- Pulse and Video Amplifiers
- Wideband Amplifiers
- RF/IF Signal Processing
- Flash A/D Driver
- Medical Imaging Systems

### Description

The HFA1100/883 is a high speed, wideband, fast settling current feedback amplifier. Built with Intersil' proprietary, complementary bipolar UHF-1 process, it is the fastest monolithic amplifier available from any semiconductor manufacturer.

The HFA1100/883's wide bandwidth, fast settling characteristic, and low output impedance, make this amplifier ideal for driving fast A/D converters.

Component and composite video systems will also benefit from this amplifier's performance, as indicated by the excellent gain flatness, and 0.03%/0.05 Deg. Differential Gain/Phase specifications ( $R_L = 75\Omega$ ).

### Ordering Information

PART NUMBER	TEMPERATURE RANGE	PACKAGE
HFA1100MJ/883	-55°C to +125°C	8 Lead CerDIP

### Pinout

HFA1100/883  
(CERDIP)  
TOP VIEW

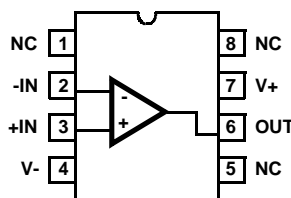

# Specifications HFA1100/883

## Absolute Maximum Ratings

Voltage Between V+ and V-	12V
Differential Input Voltage	5V
Voltage at Either Input Terminal	V+ to V-
Output Current (50% Duty Cycle)	±55mA
Junction Temperature	+175°C
ESD Rating	< 2000V
Storage Temperature Range	-65°C ≤ T <sub>A</sub> ≤ +150°C
Lead Temperature (Soldering 10s)	+300°C

## Thermal Information

Thermal Resistance	$\theta_{JA}$	$\theta_{JC}$
CerDIP Package	115°C/W	30°C/W
Maximum Package Power Dissipation at +75°C		
CerDIP Package		0.87W
Package Power Dissipation Derating Factor above +75°C		
CerDIP Package		8.7mW/°C

*CAUTION: Stresses above those listed in "Absolute Maximum Ratings" may cause permanent damage to the device. This is a stress only rating and operation of the device at these or any other conditions above those indicated in the operational sections of this specification is not implied.*

## Operating Conditions

Operating V <sub>SUPPLY</sub> (±V <sub>S</sub> )	±5V	R <sub>L</sub> ≥ 50Ω
Operating Temperature Range	-55°C ≤ T <sub>A</sub> ≤ +125°C	

**TABLE 1. DC ELECTRICAL PERFORMANCE CHARACTERISTICS**

Device Tested at: V<sub>SUPPLY</sub> = ±5V, A<sub>V</sub> = +1, R<sub>F</sub> = 510Ω, R<sub>SOURCE</sub> = 0Ω, R<sub>L</sub> = 100Ω, V<sub>OUT</sub> = 0V, Unless Otherwise Specified.

PARAMETERS	SYMBOL	CONDITIONS	GROUP A SUBGROUPS	TEMPERATURE	LIMITS		UNITS
					MIN	MAX	
Input Offset Voltage	V <sub>IO</sub>	V <sub>CM</sub> = 0V	1	+25°C	-6	6	mV
			2, 3	+125°C, -55°C	-10	10	mV
Common Mode Rejection Ratio	CMRR	ΔV <sub>CM</sub> = ±2V V+ = 3V, V- = -7V V+ = 7V, V- = -3V	1	+25°C	40	-	dB
			2, 3	+125°C, -55°C	38	-	dB
Power Supply Rejection Ratio	PSRRP	ΔV <sub>SUPPLY</sub> = ±1.25V V+ = 6.25V, V- = -5V V+ = 3.75V, V- = -5V	1	+25°C	45	-	dB
			2, 3	+125°C, -55°C	42	-	dB
	PSRRN	ΔV <sub>SUPPLY</sub> = ±1.25V V+ = 5V, V- = -6.25V V+ = 5V, V- = -3.75V	1	+25°C	45	-	dB
			2, 3	+125°C, -55°C	42	-	dB
Non-Inverting Input (+IN) Current	I <sub>BSP</sub>	V <sub>CM</sub> = 0V	1	+25°C	-40	40	μA
			2, 3	+125°C, -55°C	-65	65	μA
+IN Current Common Mode Sensitivity	CMS <sub>IBP</sub>	ΔV <sub>CM</sub> = ±2V V+ = 3V, V- = -7V V+ = 7V, V- = -3V	1	+25°C	-	40	μA/V
			2, 3	+125°C, -55°C	-	50	μA/V
+IN Resistance	+R <sub>IN</sub>	Note 1	1	+25°C	25	-	kΩ
			2, 3	+125°C, -55°C	20	-	kΩ
Inverting Input (-IN) Current	I <sub>BSN</sub>	V <sub>CM</sub> = 0V	1	+25°C	-50	50	μA
			2, 3	+125°C, -55°C	-75	75	μA
-IN Current Common Mode Sensitivity	CMS <sub>IBN</sub>	ΔV <sub>CM</sub> = ±2V V+ = 3V, V- = -7V V+ = 7V, V- = -3V	1	+25°C	-	7	μA/V
			2, 3	+125°C, -55°C	-	10	μA/V
-IN Current Power Supply Sensitivity	PPSS <sub>IBN</sub>	ΔV <sub>SUPPLY</sub> = ±1.25V V+ = 6.25V, V- = -5V V+ = 3.75V, V- = -5V	1	+25°C	-	15	μA/V
			2, 3	+125°C, -55°C	-	27	μA/V
	NPSS <sub>IBN</sub>	ΔV <sub>SUPPLY</sub> = ±1.25V V+ = 5V, V- = -6.25V V+ = 5V, V- = -3.75V	1	+25°C	-	15	μA/V
			2, 3	+125°C, -55°C	-	27	μA/V
Output Voltage Swing	V <sub>OP100</sub>	A <sub>V</sub> = -1 R <sub>L</sub> = 100Ω	1	+25°C	3	-	V
		V <sub>IN</sub> = -3.5V V <sub>IN</sub> = -3V	2, 3	+125°C, -55°C	2.5	-	V
	V <sub>ON100</sub>	A <sub>V</sub> = -1 R <sub>L</sub> = 100Ω	1	+25°C	-	-3	V
		V <sub>IN</sub> = +3.5V V <sub>IN</sub> = +3V	2, 3	+125°C, -55°C	-	-2.5	V

## Specifications HFA1100/883

**TABLE 1. DC ELECTRICAL PERFORMANCE CHARACTERISTICS (Continued)**

Device Tested at:  $V_{SUPPLY} = \pm 5V$ ,  $A_V = +1$ ,  $R_F = 510\Omega$ ,  $R_{SOURCE} = 0\Omega$ ,  $R_L = 100\Omega$ ,  $V_{OUT} = 0V$ , Unless Otherwise Specified.

PARAMETERS	SYMBOL	CONDITIONS	GROUP A SUBGROUPS	TEMPERATURE	LIMITS		UNITS	
					MIN	MAX		
Output Voltage Swing	$V_{OP50}$	$A_V = -1$ $R_L = 50\Omega$	$V_{IN} = -3V$	1, 2	+25°C, +125°C	2.5	-	V
			$V_{IN} = -2V$	3	-55°C	1.5	-	V
	$V_{ON50}$	$A_V = -1$ $R_L = 50\Omega$	$V_{IN} = +3V$	1, 2	+25°C, +125°C	-	-2.5	V
			$V_{IN} = +2V$	3	-55°C	-	-1.5	V
Output Current	$+I_{OUT}$	Note 2	1, 2	+25°C, +125°C	50	-	mA	
			3	-55°C	30	-	mA	
	$-I_{OUT}$	Note 2	1, 2	+25°C, +125°C	-	-50	mA	
			3	-55°C	-	-30	mA	
Quiescent Power Supply Current	$I_{CC}$	$R_L = 100\Omega$	1	+25°C	14	26	mA	
			2, 3	+125°C, -55°C	-	33	mA	
	$I_{EE}$	$R_L = 100\Omega$	1	+25°C	-26	-14	mA	
			2, 3	+125°C, -55°C	-33	-	mA	

**NOTES:**

- Guaranteed from +IN Common Mode Rejection Test, by:  $+R_{IN} = 1/CMS_{IBP}$ .
- Guaranteed from  $V_{OUT}$  Test with  $R_L = 50\Omega$ , by:  $I_{OUT} = V_{OUT}/50\Omega$ .

**TABLE 2. AC ELECTRICAL PERFORMANCE CHARACTERISTICS**

Table 2 Intentionally Left Blank. See AC Specifications in Table 3

**TABLE 3. ELECTRICAL PERFORMANCE CHARACTERISTICS**

Device Characterized at:  $V_{SUPPLY} = \pm 5V$ ,  $A_V = +2$ ,  $R_F = 360\Omega$ ,  $R_L = 100\Omega$ , Unless Otherwise Specified.

PARAMETERS	SYMBOL	CONDITIONS	NOTES	TEMPERATURE	LIMITS		UNITS
					MIN	MAX	
-3dB Bandwidth	BW(-1)	$A_V = -1$ , $R_F = 430\Omega$ $V_{OUT} = 200mV_{P-P}$	1	+25°C	300	-	MHz
	BW(+1)	$A_V = +1$ , $R_F = 510\Omega$ $V_{OUT} = 200mV_{P-P}$	1	+25°C	550	-	MHz
	BW(+2)	$A_V = +2$ , $V_{OUT} = 200mV_{P-P}$	1	+25°C	350	-	MHz
Gain Flatness	GF30	$A_V = +2$ , $R_F = 510\Omega$ , $f \leq 30MHz$ $V_{OUT} = 200mV_{P-P}$	1	+25°C	-	$\pm 0.04$	dB
	GF50	$A_V = +2$ , $R_F = 510\Omega$ , $f \leq 50MHz$ $V_{OUT} = 200mV_{P-P}$	1	+25°C	-	$\pm 0.10$	dB
	GF100	$A_V = +2$ , $R_F = 510\Omega$ , $f \leq 100MHz$ $V_{OUT} = 200mV_{P-P}$	1	+25°C	-	$\pm 0.30$	dB

## Specifications HFA1100/883

**TABLE 3. ELECTRICAL PERFORMANCE CHARACTERISTICS (Continued)**

Device Characterized at:  $V_{SUPPLY} = \pm 5V$ ,  $A_V = +2$ ,  $R_F = 360\Omega$ ,  $R_L = 100\Omega$ , Unless Otherwise Specified.

PARAMETERS	SYMBOL	CONDITIONS	NOTES	TEMPERATURE	LIMITS		UNITS
					MIN	MAX	
Slew Rate	+SR(+1)	$A_V = +1, R_F = 510\Omega, V_{OUT} = 5V_{P-P}$	1, 2	+25°C	1200	-	V/ $\mu$ s
	-SR(+1)	$A_V = +1, R_F = 510\Omega, V_{OUT} = 5V_{P-P}$	1, 2	+25°C	1100	-	V/ $\mu$ s
	+SR(+2)	$A_V = +2, V_{OUT} = 5V_{P-P}$	1, 2	+25°C	1650	-	V/ $\mu$ s
	-SR(+2)	$A_V = +2, V_{OUT} = 5V_{P-P}$	1, 2	+25°C	1500	-	V/ $\mu$ s
Rise and Fall Time	$T_R$	$A_V = +2, V_{OUT} = 0.5V_{P-P}$	1, 2	+25°C	-	1	ns
	$T_F$	$A_V = +2, V_{OUT} = 0.5V_{P-P}$	1, 2	+25°C	-	1	ns
Overshoot	+OS	$A_V = +2, V_{OUT} = 0.5V_{P-P}$	1, 3	+25°C	-	25	%
	-OS	$A_V = +2, V_{OUT} = 0.5V_{P-P}$	1, 3	+25°C	-	20	%
Settling Time	TS(0.1)	$A_V = +2, R_F = 510\Omega$ $V_{OUT} = 2V$ to 0V, to 0.1%	1	+25°C	-	20	ns
	TS(0.05)	$A_V = +2, R_F = 510\Omega$ $V_{OUT} = 2V$ to 0V, to 0.05%	1	+25°C	-	33	ns
2nd Harmonic Distortion	HD2(30)	$A_V = +2, f = 30MHz, V_{OUT} = 2V_{P-P}$	1	+25°C	-	-48	dBc
	HD2(50)	$A_V = +2, f = 50MHz, V_{OUT} = 2V_{P-P}$	1	+25°C	-	-45	dBc
	HD2(100)	$A_V = +2, f = 100MHz,$ $V_{OUT} = 2V_{P-P}$	1	+25°C	-	-35	dBc
3rd Harmonic Distortion	HD3(30)	$A_V = +2, f = 30MHz, V_{OUT} = 2V_{P-P}$	1	+25°C	-	-65	dBc
	HD3(50)	$A_V = +2, f = 50MHz, V_{OUT} = 2V_{P-P}$	1	+25°C	-	-60	dBc
	HD3(100)	$A_V = +2, f = 100MHz,$ $V_{OUT} = 2V_{P-P}$	1	+25°C	-	-40	dBc

**NOTES:**

- Parameters listed in Table 3 are controlled via design or process parameters and are not directly tested at final production. These parameters are lab characterized upon initial design release, or upon design changes. These parameters are guaranteed by characterization based upon data from multiple production runs which reflect lot-to-lot and within lot variation.
- Measured between 10% and 90% points.
- For 200ps input transition times. Overshoot decreases as input transition times increase, especially for  $A_V = +1$ . Please refer to Performance Curves.

**TABLE 4. ELECTRICAL TEST REQUIREMENTS**

MIL-STD-883 TEST REQUIREMENTS	SUBGROUPS (SEE TABLE 1)
Interim Electrical Parameters (Pre Burn-In)	1
Final Electrical Test Parameters	1 (Note 1), 2, 3
Group A Test Requirements	1, 2, 3
Groups C and D Endpoints	1

**NOTE:**

- PDA applies to Subgroup 1 only.

**Die Characteristics**

**DIE DIMENSIONS:**

63 x 44 x 19 mils  $\pm$  1 mils  
1600 $\mu$ m x 1130 $\mu$ m x 483 $\mu$ m  $\pm$  25.4 $\mu$ m

**METALLIZATION:**

Type: Metal 1: AlCu(2%)/TiW      Type: Metal 2: AlCu(2%)  
Thickness: Metal 1: 8k $\text{\AA}$   $\pm$  0.4k $\text{\AA}$       Thickness: Metal 2: 16k $\text{\AA}$   $\pm$  0.8k $\text{\AA}$

**GLASSIVATION:**

Type: Nitride  
Thickness: 4k $\text{\AA}$   $\pm$  0.5k $\text{\AA}$

**WORST CASE CURRENT DENSITY:**

2.0 x 10<sup>5</sup> A/cm<sup>2</sup> at 47.5mA

**TRANSISTOR COUNT:** 52

**SUBSTRATE POTENTIAL (Powered Up):** Floating (Recommend Connection to V-)

**Metallization Mask Layout**

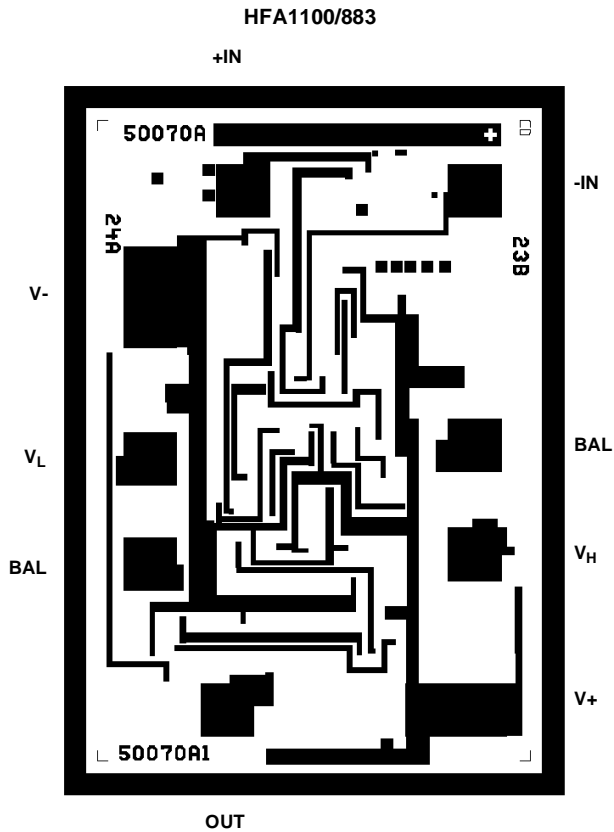

**Test Circuit** (Applies to Table 1)

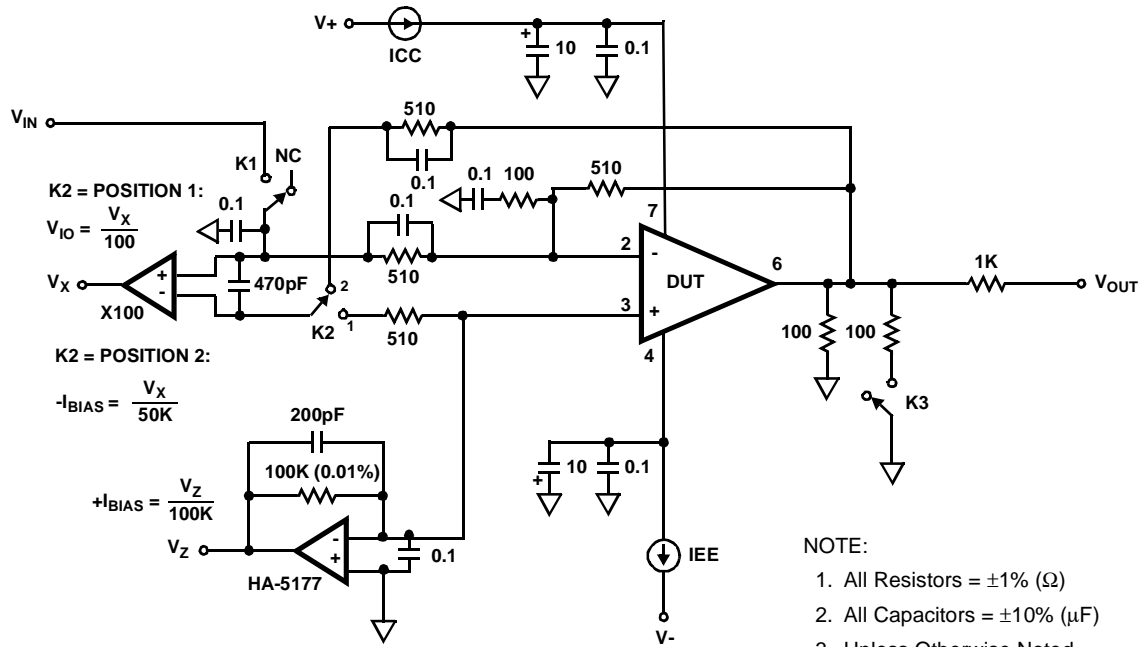

- NOTE:
1. All Resistors =  $\pm 1\%$  ( $\Omega$ )
  2. All Capacitors =  $\pm 10\%$  ( $\mu\text{F}$ )
  3. Unless Otherwise Noted
  4. Chip Components Recommended

**Test Waveforms**

**SIMPLIFIED TEST CIRCUIT FOR LARGE AND SMALL SIGNAL PULSE RESPONSE** (Applies to Table 3)

**$A_V = +1$  TEST CIRCUIT**

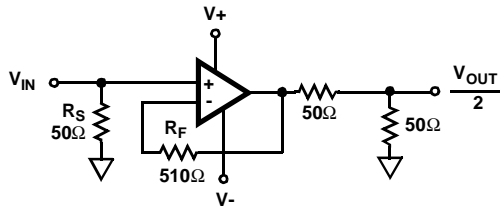

- NOTE:
1.  $V_S = \pm 5\text{V}$ ,  $A_V = +1$
  2.  $R_S = 50\Omega$
  3.  $R_L = 100\Omega$  For Small and Large Signals

**$A_V = +2$  TEST CIRCUIT**

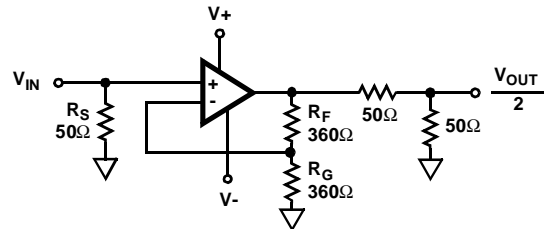

- NOTE:
1.  $V_S = \pm 5\text{V}$ ,  $A_V = +2$
  2.  $R_S = 50\Omega$
  3.  $R_L = 100\Omega$  For Small and Large Signals

**LARGE SIGNAL WAVEFORM**

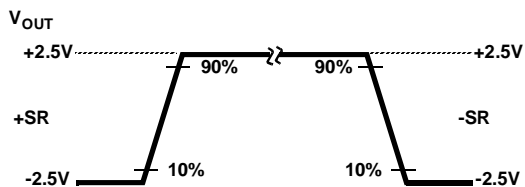

**SMALL SIGNAL WAVEFORM**

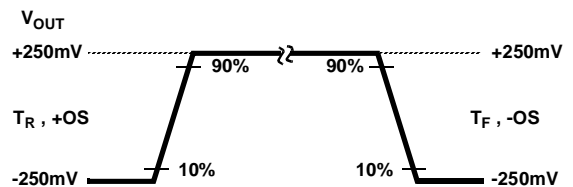

**Burn-In Circuit**

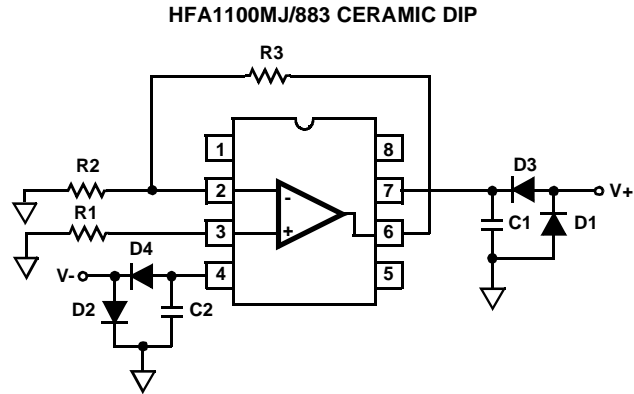

NOTES:

1. R1 = R2 = 1k $\Omega$ ,  $\pm$ 5% (Per Socket)
2. R3 = 10k $\Omega$ ,  $\pm$ 5% (Per Socket)
3. C1 = C2 = 0.01 $\mu$ F (Per Socket) or 0.1 $\mu$ F (Per Row) Minimum
4. D1 = D2 = 1N4002 or Equivalent (Per Board)
5. D3 = D4 = 1N4002 or Equivalent (Per Socket)
6. V+ = +5.5V  $\pm$  0.5V
7. V- = -5.5V  $\pm$  0.5V

**Packaging**

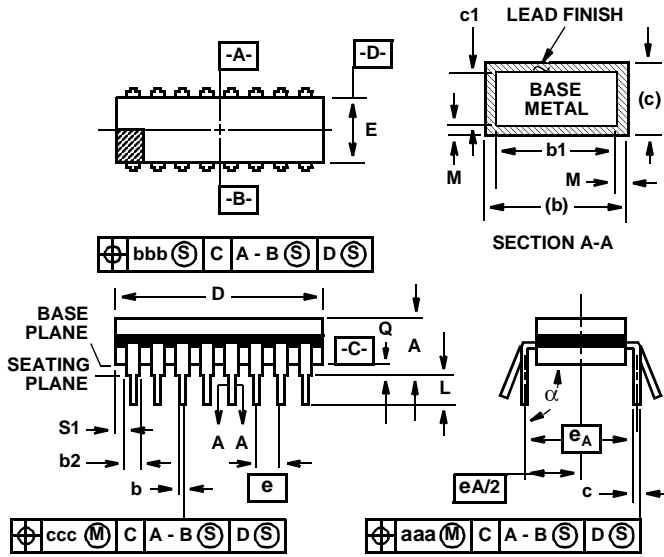

**F8.3A MIL-STD-1835 GDIP1-T8 (D-4, CONFIGURATION A)  
8 LEAD DUAL-IN-LINE FRIT-SEAL CERAMIC PACKAGE**

SYMBOL	INCHES		MILLIMETERS		NOTES
	MIN	MAX	MIN	MAX	
A	-	0.200	-	5.08	-
b	0.014	0.026	0.36	0.66	2
b1	0.014	0.023	0.36	0.58	3
b2	0.045	0.065	1.14	1.65	-
b3	0.023	0.045	0.58	1.14	4
c	0.008	0.018	0.20	0.46	2
c1	0.008	0.015	0.20	0.38	3
D	-	0.405	-	10.29	5
E	0.220	0.310	5.59	7.87	5
e	0.100 BSC		2.54 BSC		-
eA	0.300 BSC		7.62 BSC		-
eA/2	0.150 BSC		3.81 BSC		-
L	0.125	0.200	3.18	5.08	-
Q	0.015	0.060	0.38	1.52	6
S1	0.005	-	0.13	-	7
S2	0.005	-	0.13	-	-
$\alpha$	90°	105°	90°	105°	-
aaa	-	0.015	-	0.38	-
bbb	-	0.030	-	0.76	-
ccc	-	0.010	-	0.25	-
M	-	0.0015	-	0.038	2
N	8		8		8

**NOTES:**

1. Index area: A notch or a pin one identification mark shall be located adjacent to pin one and shall be located within the shaded area shown. The manufacturer's identification shall not be used as a pin one identification mark.
2. The maximum limits of lead dimensions b and c or M shall be measured at the centroid of the finished lead surfaces, when solder dip or tin plate lead finish is applied.
3. Dimensions b1 and c1 apply to lead base metal only. Dimension M applies to lead plating and finish thickness.
4. Corner leads (1, N, N/2, and N/2+1) may be configured with a partial lead paddle. For this configuration dimension b3 replaces dimension b1.
5. This dimension allows for off-center lid, meniscus, and glass overrun.
6. Dimension Q shall be measured from the seating plane to the base plane.
7. Measure dimension S1 at all four corners.
8. N is the maximum number of terminal positions.
9. Dimensioning and tolerancing per ANSI Y14.5M - 1982.
10. Controlling Dimension: Inch.
11. Lead Finish: Type A.
12. Materials: Compliant to MIL-I-38535.



## DESIGN INFORMATION

February 2002

## Ultra High Speed Current Feedback Amplifier

The information contained in this section has been developed through characterization by Intersil Semiconductor and is for use as application and design information only. No guarantee is implied.

**Typical Performance Curves**  $V_{SUPPLY} = \pm 5V$ ,  $R_F = 510\Omega$ ,  $R_L = 100\Omega$ ,  $T_A = +25^\circ C$ , Unless Otherwise Specified

**SMALL SIGNAL PULSE RESPONSE ( $A_V = +2$ )**

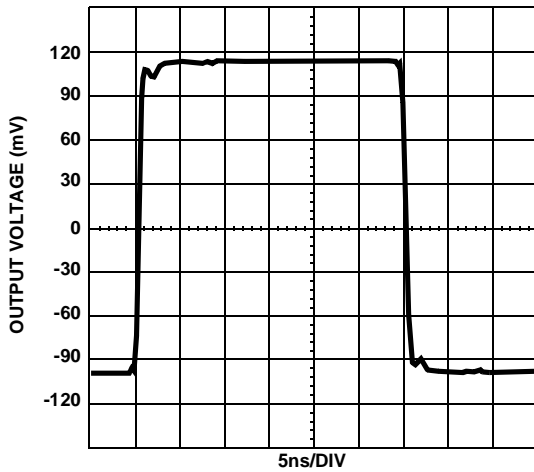

**LARGE SIGNAL PULSE RESPONSE ( $A_V = +2$ )**

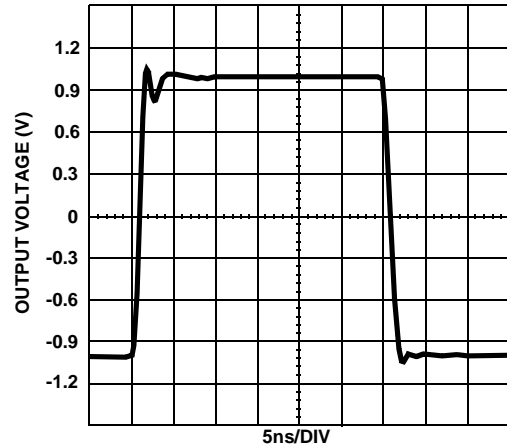

**NON-INVERTING FREQUENCY RESPONSE ( $V_{OUT} = 200mV_{P-P}$ )**

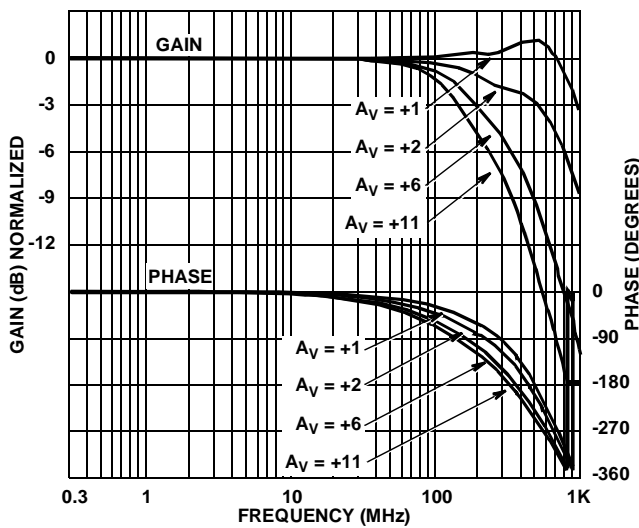

**INVERTING FREQUENCY RESPONSE ( $V_{OUT} = 200mV_{P-P}$ )**

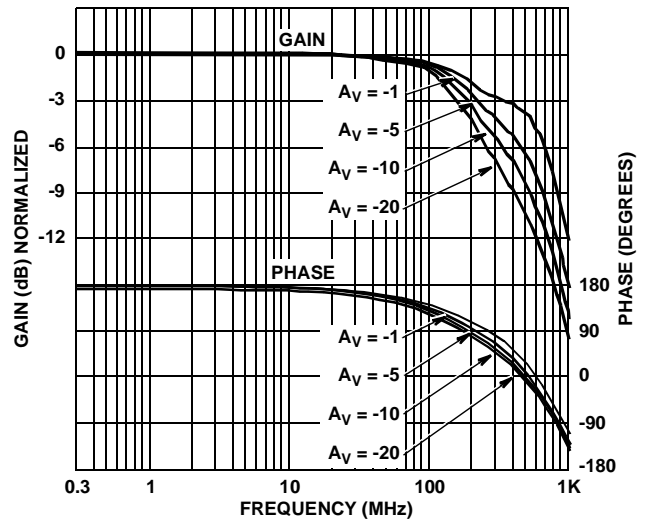

## DESIGN INFORMATION (Continued)

The information contained in this section has been developed through characterization by Intersil Semiconductor and is for use as application and design information only. No guarantee is implied.

**Typical Performance Curves**  $V_{SUPPLY} = \pm 5V$ ,  $R_F = 510\Omega$ ,  $R_L = 100\Omega$ ,  $T_A = +25^\circ C$ , Unless Otherwise Specified

**FREQUENCY RESPONSE FOR VARIOUS LOAD RESISTORS**  
( $A_V = +1$ ,  $V_{OUT} = 200mV_{P-P}$ )

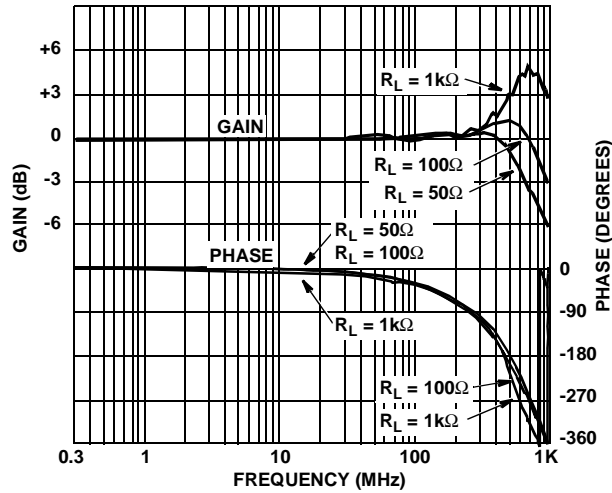

**FREQUENCY RESPONSE FOR VARIOUS LOAD RESISTORS**  
( $A_V = +2$ ,  $V_{OUT} = 200mV_{P-P}$ )

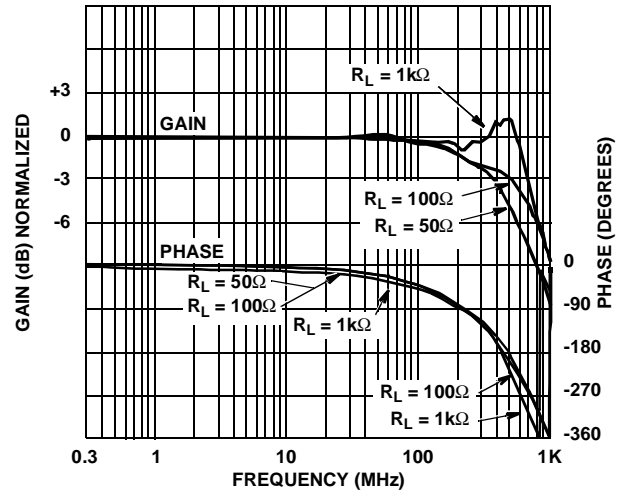

**FREQUENCY RESPONSE FOR VARIOUS OUTPUT VOLTAGES**  
( $A_V = +1$ )

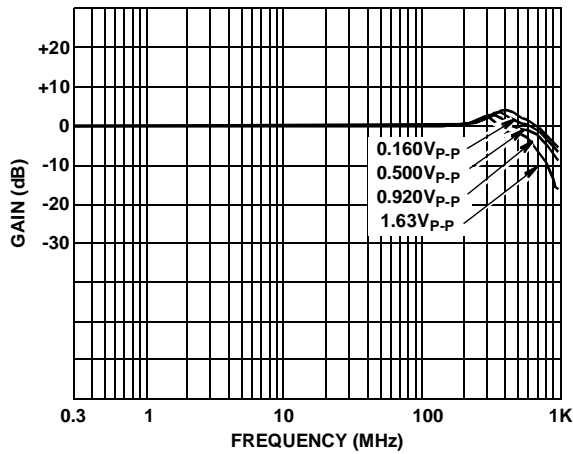

**FREQUENCY RESPONSE FOR VARIOUS OUTPUT VOLTAGES**  
( $A_V = +2$ )

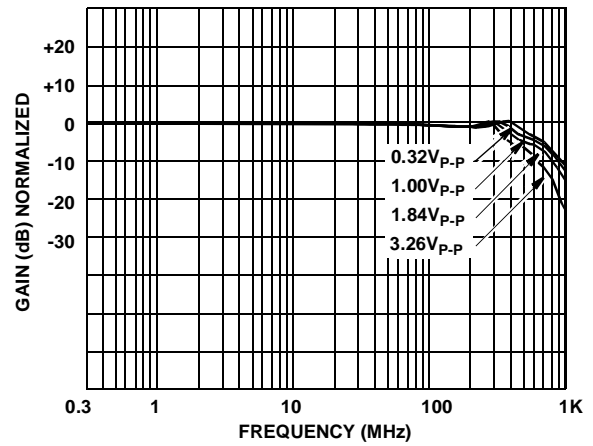

**FREQUENCY RESPONSE FOR VARIOUS OUTPUT VOLTAGES**  
( $A_V = +6$ )

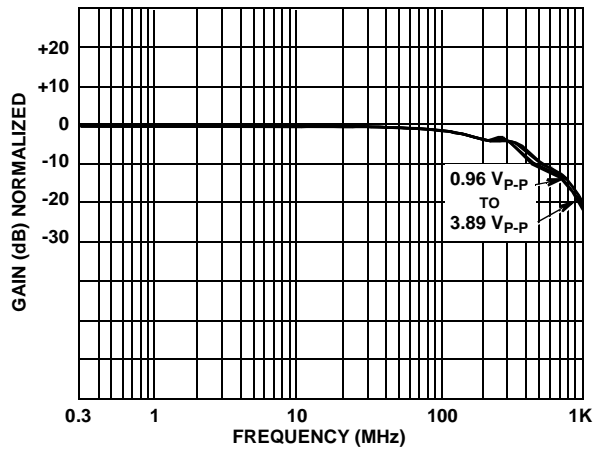

**-3dB BANDWIDTH vs TEMPERATURE ( $A_V = +1$ )**

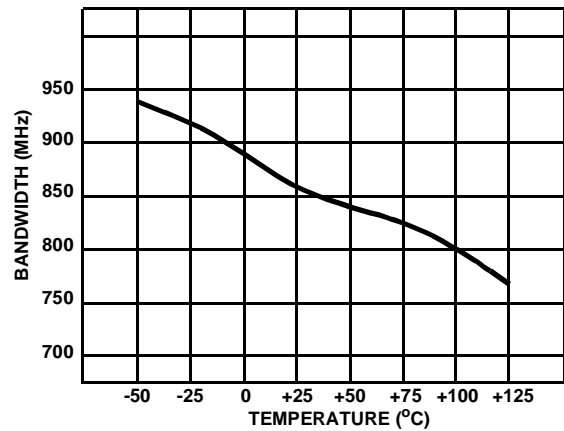

## DESIGN INFORMATION (Continued)

The information contained in this section has been developed through characterization by Intersil Semiconductor and is for use as application and design information only. No guarantee is implied.

**Typical Performance Curves**  $V_{SUPPLY} = \pm 5V$ ,  $R_F = 510\Omega$ ,  $R_L = 100\Omega$ ,  $T_A = +25^\circ C$ , Unless Otherwise Specified

**GAIN FLATNESS ( $A_V = +2$ )**

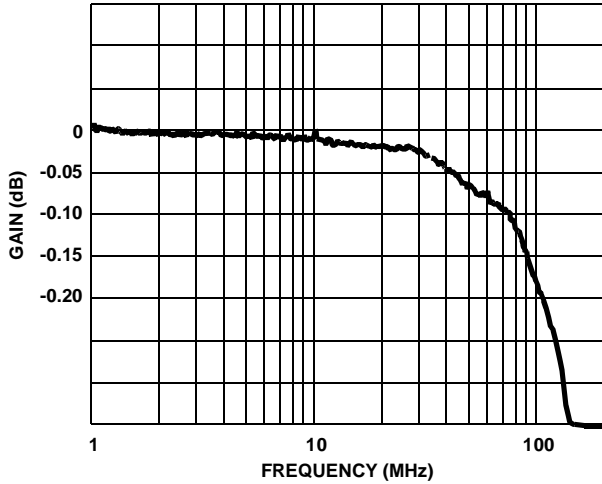

**DEVIATION FROM LINEAR PHASE ( $A_V = +2$ )**

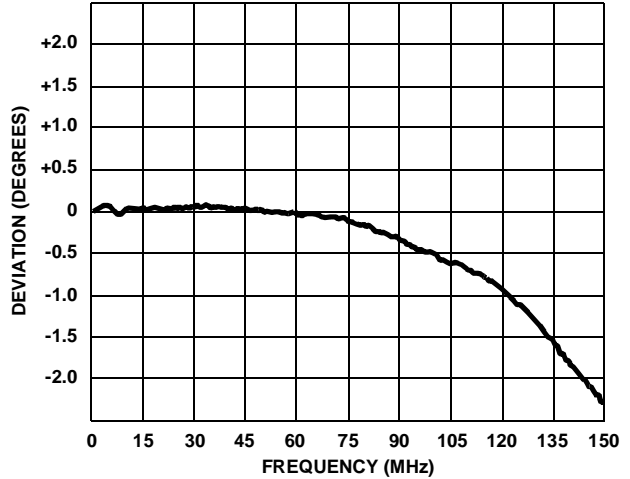

**SETTLING RESPONSE ( $A_V = +2$ ,  $V_{OUT} = 2V$ )**

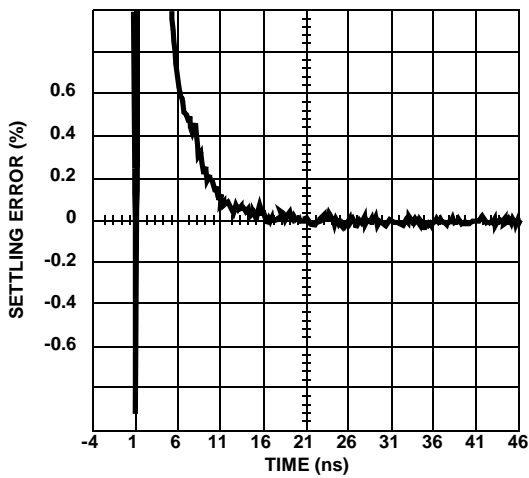

**3RD ORDER INTERMODULATION INTERCEPT (2-TONE)**

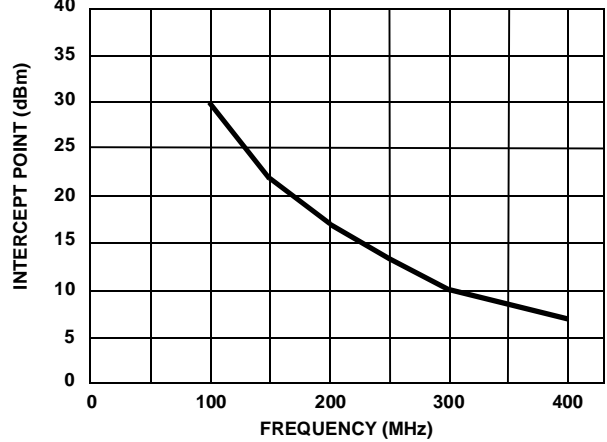

**2nd HARMONIC DISTORTION vs  $P_{OUT}$**

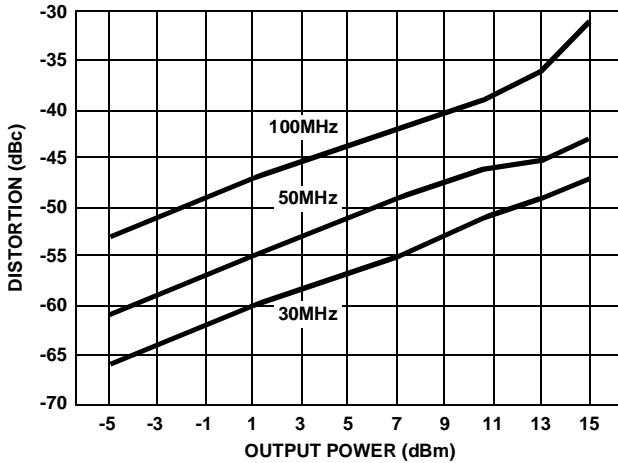

**3rd HARMONIC DISTORTION vs  $P_{OUT}$**

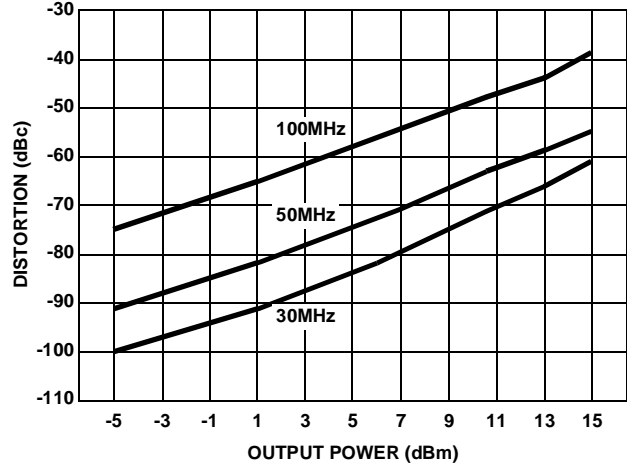

## DESIGN INFORMATION (Continued)

The information contained in this section has been developed through characterization by Intersil Semiconductor and is for use as application and design information only. No guarantee is implied.

**Typical Performance Curves**  $V_{SUPPLY} = \pm 5V$ ,  $R_F = 510\Omega$ ,  $R_L = 100\Omega$ ,  $T_A = +25^\circ C$ , Unless Otherwise Specified

OVERSHOOT vs INPUT RISE TIME ( $A_V = +1$ )

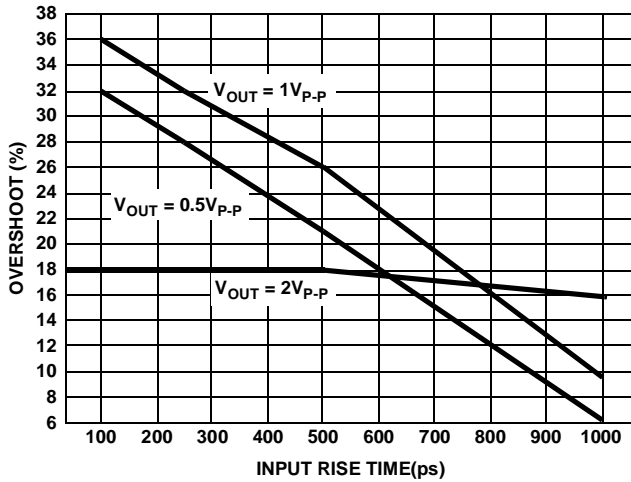

OVERSHOOT vs INPUT RISE TIME ( $A_V = +2$ )

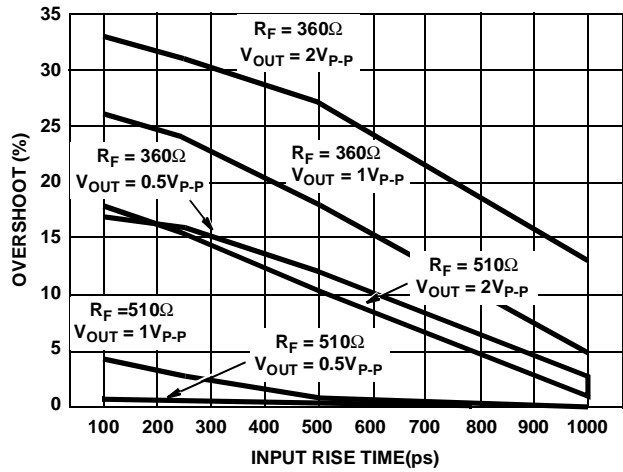

OVERSHOOT vs FEEDBACK RESISTOR ( $A_V = +2$ ,  $t_R = 200ps$ ,  $V_{OUT} = 2V_{P-P}$ )

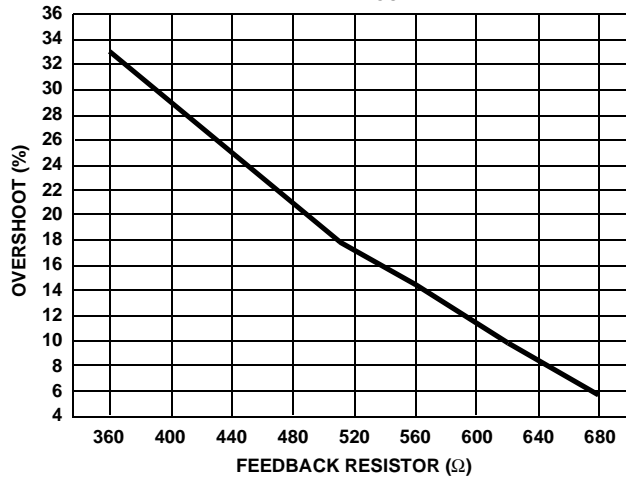

SUPPLY CURRENT vs TEMPERATURE

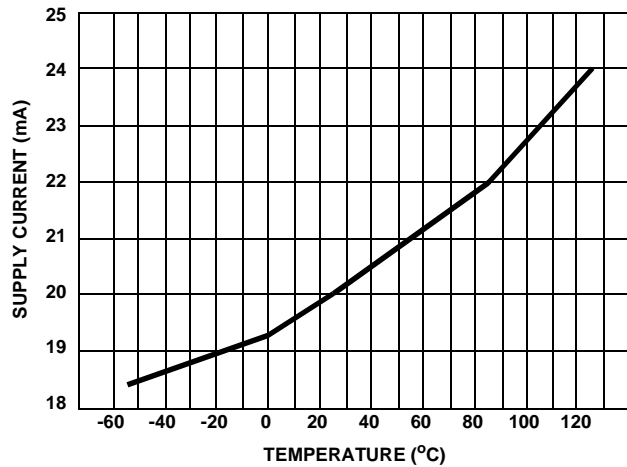

SUPPLY CURRENT vs SUPPLY VOLTAGE

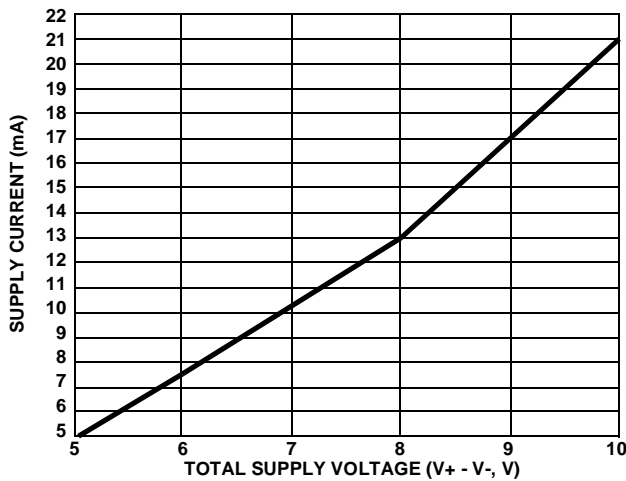

$V_{IO}$  AND BIAS CURRENTS vs TEMPERATURE

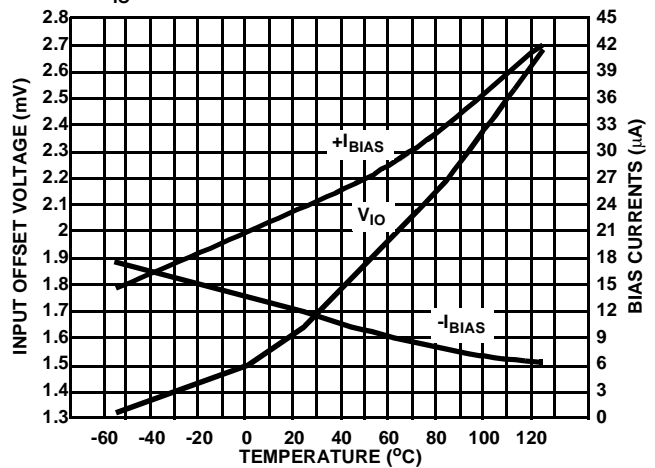

## DESIGN INFORMATION (Continued)

The information contained in this section has been developed through characterization by Intersil Semiconductor and is for use as application and design information only. No guarantee is implied.

### Typical Performance Curves $V_{SUPPLY} = \pm 5V$ , $R_F = 510\Omega$ , $R_L = 100\Omega$ , $T_A = +25^\circ C$ , Unless Otherwise Specified

**OUTPUT VOLTAGE vs TEMPERATURE**  
( $A_V = -1$ ,  $R_L = 50\Omega$ )

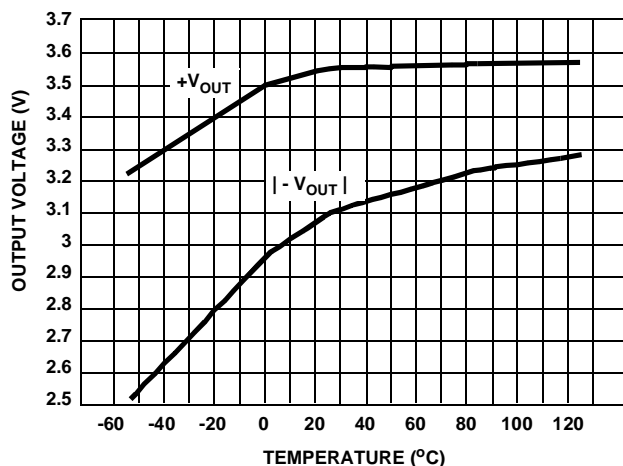

**INPUT NOISE vs FREQUENCY**

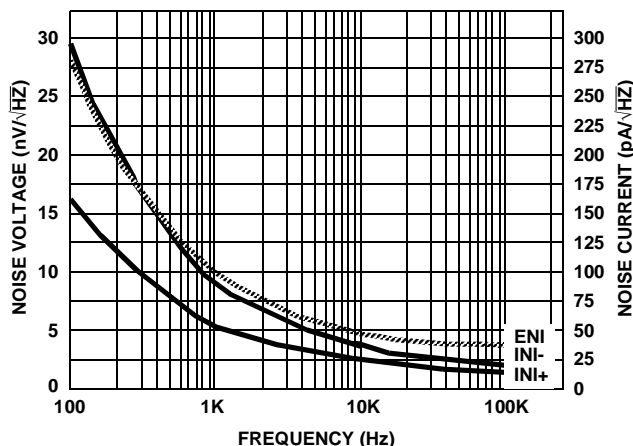

## Application Information

### Optimum Feedback Resistor

The enclosed plots of inverting and non-inverting frequency response illustrate the performance of the HFA1100 in various gains. Although the bandwidth dependency on closed loop gain isn't as severe as that of a voltage feedback amplifier, there can be an appreciable decrease in bandwidth at higher gains. This decrease may be minimized by taking advantage of the current feedback amplifier's unique relationship between bandwidth and  $R_F$ . All current feedback amplifiers require a feedback resistor, even for unity gain applications, and  $R_F$ , in conjunction with the internal compensation capacitor, sets the dominant pole of the frequency response. Thus, the amplifier's bandwidth is inversely proportional to  $R_F$ . The HFA1100 design is optimized for a  $510\Omega$   $R_F$  at a gain of +1. Decreasing  $R_F$  in a unity gain application decreases stability, resulting in excessive peaking and overshoot. At higher gains the amplifier is more stable, so  $R_F$  can be decreased in a trade-off of stability for bandwidth.

The table below lists recommended  $R_F$  values for various gains, and the expected bandwidth.

GAIN ( $A_{CL}$ )	$R_F$ ( $\Omega$ )	BANDWIDTH (MHz)
-1	430	580
+1	510	850
+2	360	670
+5	150	520
+10	180	240
+19	270	125

### PC Board Layout

The frequency response of this amplifier depends greatly on the amount of care taken in designing the PC board. **The use of low inductance components such as chip resistors and chip capacitors is strongly recommended, while a solid ground plane is a must!**

Attention should be given to decoupling the power supplies. A large value ( $10\mu F$ ) tantalum in parallel with a small value ( $0.1\mu F$ ) chip capacitor works well in most cases.

## DESIGN INFORMATION (Continued)

The information contained in this section has been developed through characterization by Intersil Semiconductor and is for use as application and design information only. No guarantee is implied.

Terminated microstrip signal lines are recommended at the input and output of the device. Capacitance directly on the output must be minimized, or isolated as discussed in the next section.

Care must also be taken to minimize the capacitance to ground seen by the amplifier's inverting input (-IN). The larger this capacitance, the worse the gain peaking, resulting in pulse overshoot and possible instability. To this end, it is recommended that the ground plane be removed under traces connected to -IN, and connections to -IN should be kept as short as possible.

An example of a good high frequency layout is the Evaluation Board shown in Figure 2.

### Driving Capacitive Loads

Capacitive loads, such as an A/D input, or an improperly terminated transmission line will degrade the amplifier's phase margin resulting in frequency response peaking and possible oscillations. In most cases, the oscillation can be avoided by placing a resistor ( $R_S$ ) in series with the output prior to the capacitance.

Figure 1 details starting points for the selection of this resistor. The points on the curve indicate the  $R_S$  and  $C_L$  combinations for the optimum bandwidth, stability, and settling time, but experimental fine tuning is recommended. Picking a point above or to the right of the curve yields an overdamped response, while points below or left of the curve indicate areas of underdamped performance.

$R_S$  and  $C_L$  form a low pass network at the output, thus limiting system bandwidth well below the amplifier bandwidth of 850MHz. By decreasing  $R_S$  as  $C_L$  increases (as illustrated in the curves), the maximum bandwidth is obtained without sacrificing stability. Even so, bandwidth does decrease as you move to the right along the curve. For example, at  $A_V = +1$ ,  $R_S = 50\Omega$ ,  $C_L = 30pF$ , the overall bandwidth is limited to 300MHz, and bandwidth drops to 100MHz at  $A_V = +1$ ,  $R_S = 5\Omega$ ,  $C_L = 340pF$ .

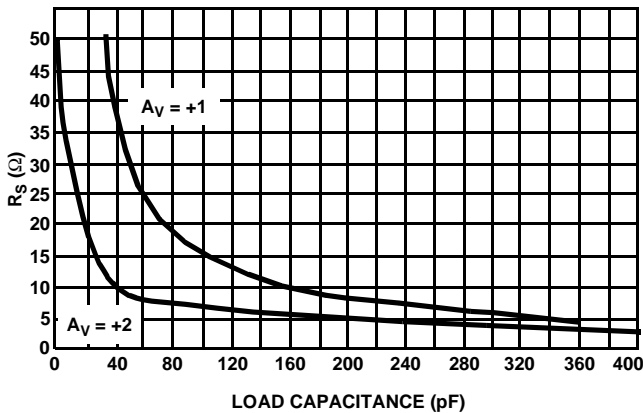

FIGURE 1. RECOMMENDED SERIES OUTPUT RESISTOR vs LOAD CAPACITANCE

### Evaluation Board

The performance of the HFA1100 may be evaluated using the HFA11XX Evaluation Board.

The layout and schematic of the board are shown in Figure 2. To order evaluation boards, please contact your local sales office.

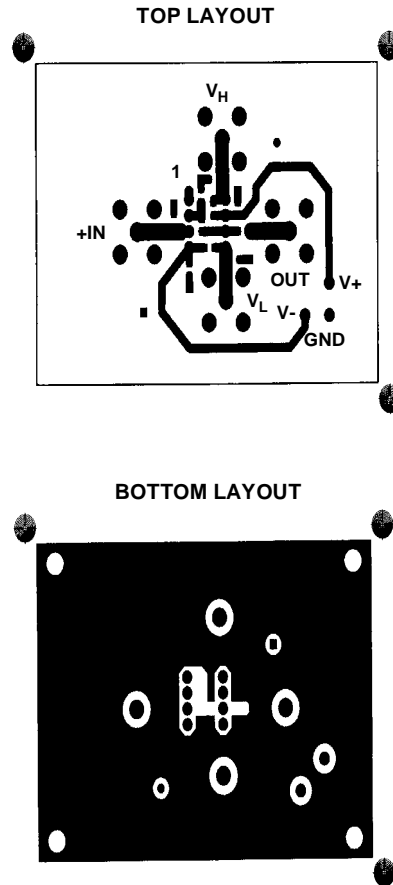

FIGURE 2. EVALUATION BOARD SCHEMATIC AND LAYOUT

## DESIGN INFORMATION (Continued)

The information contained in this section has been developed through characterization by Intersil Semiconductor and is for use as application and design information only. No guarantee is implied.

### TYPICAL PERFORMANCE CHARACTERISTICS

Device Characterized at:  $V_{SUPPLY} = \pm 5V$ ,  $R_F = 360\Omega$ ,  $A_V = +2V/V$ ,  $R_L = 100\Omega$ , Unless Otherwise Specified

PARAMETERS	CONDITIONS	TEMPERATURE	TYPICAL	UNITS
Input Offset Voltage *	$V_{CM} = 0V$	+25°C	2	mV
Average Offset Voltage Drift	Versus Temperature	Full	10	$\mu V/^\circ C$
$V_{IO}$ CMRR	$\Delta V_{CM} = \pm 2V$	+25°C	46	dB
$V_{IO}$ PSRR	$\Delta V_S = \pm 1.25V$	+25°C	50	dB
+Input Current *	$V_{CM} = 0V$	+25°C	25	$\mu A$
Average +Input Current Drift	Versus Temperature	Full	40	$nA/^\circ C$
- Input Current *	$V_{CM} = 0V$	+25°C	12	$\mu A$
Average -Input Current Drift	Versus Temperature	Full	40	$nA/^\circ C$
+Input Resistance	$\Delta V_{CM} = \pm 2V$	+25°C	50	k $\Omega$
- Input Resistance		+25°C	16	$\Omega$
Input Capacitance		+25°C	2.2	pF
Input Noise Voltage *	f = 100kHz	+25°C	4	$nV/\sqrt{Hz}$
+Input Noise Current *	f = 100kHz	+25°C	18	$pA/\sqrt{Hz}$
-Input Noise Current *	f = 100kHz	+25°C	21	$pA/\sqrt{Hz}$
Input Common Mode Range		Full	$\pm 3.0$	V
Open Loop Transimpedance	$A_V = -1$	+25°C	500	k $\Omega$
Output Voltage	$A_V = -1$ , $R_L = 100\Omega$	+25°C	$\pm 3.3$	V
	$A_V = -1$ , $R_L = 100\Omega$	Full	$\pm 3.0$	V
Output Current *	$A_V = -1$ , $R_L = 50\Omega$	+25°C to +125°C	$\pm 65$	mA
	$A_V = -1$ , $R_L = 50\Omega$	-55°C to 0°C	$\pm 50$	mA
DC Closed Loop Output Resistance		+25°C	0.1	$\Omega$
Quiescent Supply Current *	$R_L = \text{Open}$	Full	24	mA
-3dB Bandwidth *	$A_V = -1$ , $R_F = 430\Omega$ , $V_{OUT} = 200mV_{P-P}$	+25°C	580	MHz
	$A_V = +1$ , $R_F = 510\Omega$ , $V_{OUT} = 200mV_{P-P}$	+25°C	850	MHz
	$A_V = +2$ , $R_F = 360\Omega$ , $V_{OUT} = 200mV_{P-P}$	+25°C	670	MHz
Slew Rate	$A_V = +1$ , $R_F = 510\Omega$ , $V_{OUT} = 5V_{P-P}$	+25°C	1500	V/ $\mu s$
	$A_V = +2$ , $V_{OUT} = 5V_{P-P}$	+25°C	2300	V/ $\mu s$
Full Power Bandwidth	$V_{OUT} = 5V_{P-P}$	+25°C	220	MHz
Gain Flatness *	To 30MHz, $R_F = 510\Omega$	+25°C	$\pm 0.014$	dB
	To 50MHz, $R_F = 510\Omega$	+25°C	$\pm 0.05$	dB
	To 100MHz, $R_F = 510\Omega$	+25°C	$\pm 0.14$	dB
Linear Phase Deviation *	To 100MHz, $R_F = 510\Omega$	+25°C	$\pm 0.6$	Degrees

## DESIGN INFORMATION (Continued)

The information contained in this section has been developed through characterization by Intersil Semiconductor and is for use as application and design information only. No guarantee is implied.

### TYPICAL PERFORMANCE CHARACTERISTICS

Device Characterized at:  $V_{SUPPLY} = \pm 5V$ ,  $R_F = 360\Omega$ ,  $A_V = +2V/V$ ,  $R_L = 100\Omega$ , Unless Otherwise Specified

PARAMETERS	CONDITIONS	TEMPERATURE	TYPICAL	UNITS
2nd Harmonic Distortion *	30MHz, $V_{OUT} = 2V_{P-P}$	+25°C	-55	dBc
	50MHz, $V_{OUT} = 2V_{P-P}$	+25°C	-49	dBc
	100MHz, $V_{OUT} = 2V_{P-P}$	+25°C	-44	dBc
3rd Harmonic Distortion *	30MHz, $V_{OUT} = 2V_{P-P}$	+25°C	-84	dBc
	50MHz, $V_{OUT} = 2V_{P-P}$	+25°C	-70	dBc
	100MHz, $V_{OUT} = 2V_{P-P}$	+25°C	-57	dBc
3rd Order Intercept *	100MHz, $R_F = 510\Omega$	+25°C	30	dBm
1dB Compression	100MHz, $R_F = 510\Omega$	+25°C	20	dBm
Reverse Isolation ( $S_{12}$ )	40MHz, $R_F = 510\Omega$	+25°C	-70	dB
	100MHz, $R_F = 510\Omega$	+25°C	-60	dB
	600MHz, $R_F = 510\Omega$	+25°C	-32	dB
Rise & Fall Time	$V_{OUT} = 0.5V_{P-P}$	+25°C	500	ps
	$V_{OUT} = 2V_{P-P}$	+25°C	800	ps
Overshoot *	$V_{OUT} = 0.5V_{P-P}$ , Input $t_R/t_F = 550ps$	+25°C	11	%
Settling Time *	To 0.1%, $V_{OUT} = 2V$ to 0V, $R_F = 510\Omega$	+25°C	11	ns
	To 0.05%, $V_{OUT} = 2V$ to 0V, $R_F = 510\Omega$	+25°C	19	ns
	To 0.02%, $V_{OUT} = 2V$ to 0V, $R_F = 510\Omega$	+25°C	34	ns
Differential Gain	$A_V = +2$ , $R_L = 75\Omega$ , NTSC	+25°C	0.03	%
Differential Phase	$A_V = +2$ , $R_L = 75\Omega$ , NTSC	+25°C	0.05	Degrees
Overdrive Recovery Time	$R_F = 510\Omega$ , $V_{IN} = 5V_{P-P}$	+25°C	7.5	ns

\* See Typical Performance Curves for more information.

All Intersil semiconductor products are manufactured, assembled and tested under **ISO9000** quality systems certification.

*Intersil products are sold by description only. Intersil Corporation reserves the right to make changes in circuit design and/or specifications at any time without notice. Accordingly, the reader is cautioned to verify that data sheets are current before placing orders. Information furnished by Intersil is believed to be accurate and reliable. However, no responsibility is assumed by Intersil or its subsidiaries for its use; nor for any infringements of patents or other rights of third parties which may result from its use. No license is granted by implication or otherwise under any patent or patent rights of Intersil or its subsidiaries.*

For information regarding Intersil Corporation and its products, see web site <http://www.intersil.com>